

NIDEC MOTOR CORPORATION

8050 WEST FLORISSANT AVE.
ST. LOUIS, MO 63136



DATE: 5/13/2022

P.O. NO.: HH92
Order/Line NO.: 27329 MN 100

TO:

Model Number: HH92
Catalog Number: C500P2W
Warning
MOD,NOTES

REVISIONS:
(NONE)

**ALL DOCUMENTS HEREIN ARE CONSIDERED CERTIFIED BY NIDEC MOTOR CORPORATION.
THANK YOU FOR YOUR ORDER AND THE OPPORTUNITY TO SERVE YOU.**

Features:

Horsepower 00500.00~00000.00 ~ KW: 373.0
Enclosure TEFC
Poles 04~00 ~ RPM: 1800~0
Frame Size 5012~S
Phase/Frequency/Voltage.. 3~060~2300/4000
Winding Type Form Wound
Service Factor 1.15
Insulation Class Class "F" ~ Insulife 5000
Altitude In Feet (Max) .. 3300 Ft.(1000 M)
Ambient In Degree C (Max) +40 C
Assembly Position "F-1" Assembly Position
Efficiency Class Premium Efficiency
Application Centrifugal Pump
Customer Part Number
Self Certified Div 2 Info:
Division 2 ~ Class I ~ Group A, B, C & D
Class II N/A ~ Group N/A ~ T3 Temp Code
Zone 2 Required? Y/N No
Div 2 Service Factor ... 1.00
"AK" Dimension (Inches).. NA
Temperature Rise (Sine Wave): "B" Rise @ 1.0 SF (Resist)
Design Letter B
KVA Code Letter "G"
Starting Method Direct-On-Line Start
Duty Cycle Continuous Duty
Efficiency Value 95.0 % ~ NEMA Nominal
Sound Pressure Required (dBA) 85 dBA @ 1M Sound Pressure
Load Inertia: NEMA ~ Standard Inertia: 1880 LB-FT2
Number Of Starts Per Hour: NEMA
Motor Type Code JCE
Rotor Inertia (LB-FT²) 218. LB-FT²
Qty. of Bearings PE (Shaft) 1
Qty. of Bearings SE (OPP) 1
Bearing Number PE (Shaft) 6315-J/C3
Bearing Number SE (OPP) 6315-J/C3

Nidec trademarks followed by the ® symbol are registered with the U.S. Patent and Trademark Office.

NIDEC MOTOR CORPORATION

8050 WEST FLORISSANT AVE.
ST. LOUIS, MO 63136



DATE: 5/13/2022

P.O. NO.: HH92
Order/Line NO.: 27329 MN 100

TO:

Model Number: HH92
Catalog Number: C500P2W
Warning
MOD,NOTES

REVISIONS:
(NONE)

**ALL DOCUMENTS HEREIN ARE CONSIDERED CERTIFIED BY NIDEC MOTOR CORPORATION.
THANK YOU FOR YOUR ORDER AND THE OPPORTUNITY TO SERVE YOU.**

Accessories:

Shaft Slinger/Umbrella Seal
Stainless Steel Drains - Both
Cast Iron Fan Cover
Direct Connected To Load
Corro-Duty
Dual Rotation w/Rotation Arrow
Ground Lug In Conduit Box
Grounding Pad On Frame
Insulated Bearing - Short End
115 Volt Space Heaters
Special Space Heater Max Temp
Special Balance
Two Hole Lead Lugs
Arrange To Accomodate BTD's
Both Bearings
Winding RTD's-100 Ohm, 3 Lead
Vertical Jacking Provisions
Conduit Box Information: ~ Size 3 Conduit Box-Cast Iron
Conduit Opening Size (AA) .. 3.5" NPT
2 Conduit Openings ~ Bottom Of Conduit Box
Arrange To Accom. BTD's:
Temp. Detector Type BEARING RTDS
Manufacturer N/A
Manufacturer's Part Number.. N/A
Q-1 Accessory Outlet Box
Accessory C/B 1 Info:
Outlet Box Material Cast Iron Box
Location Of Accessory Box Opposite Side of Main O/B
1.5" NPT Conduit Opening
With Terminal Board
100 OHM RTD~SPACE HEATER~~~
Standard Leadtime: NA
Est. Weight (lbs ea): 6000 ~ F.O.B.:
PRIMARY GROUND
LOCATED IN MAIN
CONDUIT BOX

USE THE DATA PROVIDED BELOW TO SELECT THE APPROPRIATE DIMENSION PRINT

Horsepower	500
Pole(s)	04
Voltage(s)	4000-2300
Frame Size	5012S
Shaft U Diameter	2.875
Outlet Box AF	10.94
Outlet Box AA	3.5
Accessory Conduit Box 1 DM	1.5

EFFECTIVE:
22-APR-22

DIMENSION PRINT

TOTALLY ENCLOSED FAN COOLED

PRINT:
07-2690-B7

SUPERSEDES:
08-AUG-16

FRAME: 5000S, ML
BASIC TYPE: JC

SHEET:
1 OF 1

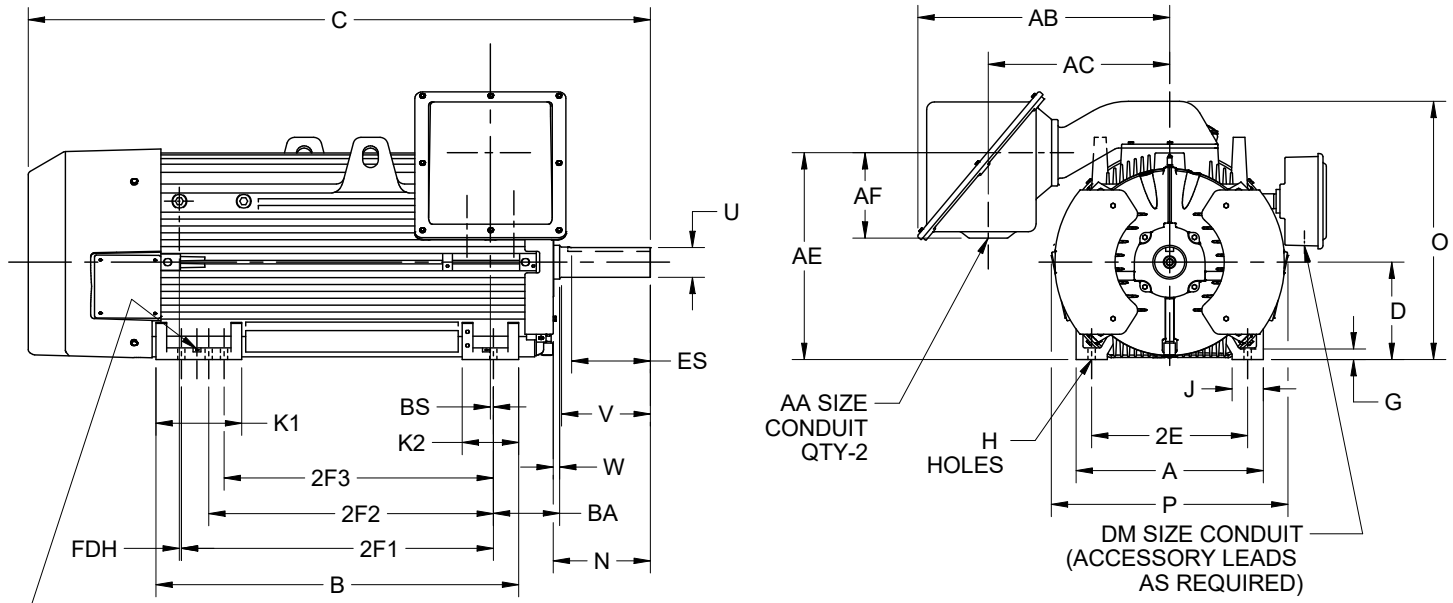

4 PILOT HOLES FOR
Ø.38 DOWEL PINS

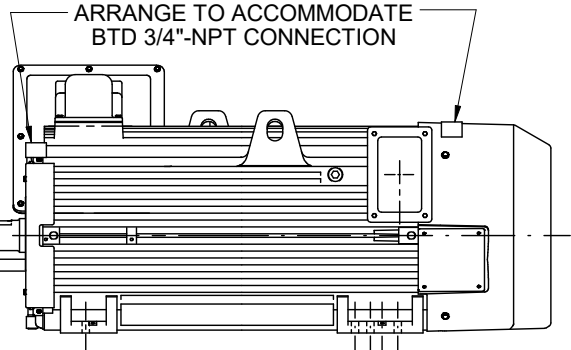

ALL DIMENSIONS ARE IN INCHES

A	D -.06	2E ±.03	G	H ⁴ +.05	J	K1	K2	O	P ²	W
24.00	12.50	20.00	1.38	.94	4.00	11.00	7.25	33.13	30.50	.69

AB	AC	AD	AE	AF	BA	BS	FDH
32.25	23.25	3.00	26.50	10.94	8.50	.38	.25

FRAME	N	U -.001	V MIN	ES MIN	SQ KEY
5000S	6.44	2.875	5.50	4.00	.750
5000ML	12.31	3.875	11.38	10.00	1.000

FRAME	B	C	2F1 ±.03	2F2 ±.03	2F3 ±.03
5008S	31.50	60.63	25.00	22.00	20.00
5008ML	31.50	66.50	25.00	22.00	20.00
5010S	38.50	67.63	32.00	28.00	N/A
5010ML	38.50	73.50	32.00	28.00	N/A
5012S	46.50	75.63	40.00	36.00	N/A
5012ML	46.50	81.50	40.00	36.00	N/A

AA
3 NPT
3 1/2 NPT
4 NPT

DM
3/4 NPT
1 NPT
1 1/4 NPT
1 1/2 NPT
2 NPT

1. DIMENSIONS MAY VARY .25" DUE TO CASTING AND/OR FABRICATION VARIATIONS.
2. LARGEST MOTOR WIDTH.
3. MAIN OUTLET BOX IS NOT ROTATABLE. HOWEVER OPENINGS ARE PROVIDED ON BOTTOM AND EACH SIDE. DIMENSIONS: 24h X 18w X 14d
4. QTY-8 HOLES ON 5008 FRAME AND QTY-6 HOLES ON ALL OTHERS.

07-2690/E

Nidec Motor Corporation
St. Louis, Missouri

INFORMATION DISCLOSED ON THIS DOCUMENT
IS CONSIDERED PROPRIETARY AND SHALL NOT BE
REPRODUCED OR DISCLOSED WITHOUT WRITTEN
CONSENT OF NIDEC MOTOR CORPORATION



ISSUED BY
L. ALBELDAÑO
APPROVED BY
M. RAMIREZ

IHP_DP_NMCA (MAR-2011) SOLIDEDGE

NAMEPLATE DATA

CATALOG NUMBER: <input style="width: 100%;" type="text" value="C500P2W"/>	NAMEPLATE PART #: <input style="width: 100%;" type="text" value="422704-006"/>
MODEL <input style="width: 100px;" type="text" value="HH92"/> <input style="width: 100px;" type="text" value="FR"/> <input style="width: 100px;" type="text" value="5012S"/>	TYPE <input style="width: 100px;" type="text" value="JCE"/> <input style="width: 100px;" type="text" value="ENCL"/> <input style="width: 100px;" type="text" value="TEFC"/>
SHAFT END BRG <input style="width: 100%;" type="text" value="6315-J/C3 - QTY 1"/>	OPP END BRG <input style="width: 100%;" type="text" value="6315-J/C3 - QTY 1"/>
PH <input style="width: 50px;" type="text" value="3"/> MAX AMB <input style="width: 100px;" type="text" value="40 C"/>	ID# <input style="width: 100%;" type="text"/>
INSUL CLASS <input style="width: 50px;" type="text" value="F"/> Asm. Pos. <input style="width: 100%;" type="text" value="F1"/>	DUTY <input style="width: 100%;" type="text" value="CONT"/>
HP <input style="width: 50px;" type="text" value="500"/> <input style="width: 50px;" type="text"/> RPM <input style="width: 50px;" type="text" value="1785"/> <input style="width: 50px;" type="text"/>	HP <input style="width: 50px;" type="text"/> <input style="width: 50px;" type="text"/> RPM <input style="width: 50px;" type="text"/> <input style="width: 50px;" type="text"/>
VOLTS <input style="width: 50px;" type="text" value="4000"/> <input style="width: 50px;" type="text" value="2300"/> <input style="width: 50px;" type="text"/>	VOLTS <input style="width: 50px;" type="text"/> <input style="width: 50px;" type="text"/> <input style="width: 50px;" type="text"/>
FL AMPS <input style="width: 50px;" type="text" value="66.0"/> <input style="width: 50px;" type="text" value="115.0"/> <input style="width: 50px;" type="text"/>	FL AMPS <input style="width: 50px;" type="text"/> <input style="width: 50px;" type="text"/> <input style="width: 50px;" type="text"/>
SF AMPS <input style="width: 50px;" type="text" value="76.0"/> <input style="width: 50px;" type="text" value="132.0"/>	SF AMPS <input style="width: 50px;" type="text"/> <input style="width: 50px;" type="text"/>
SF <input style="width: 50px;" type="text" value="1.15"/> DESIGN <input style="width: 50px;" type="text" value="B"/> CODE <input style="width: 50px;" type="text" value="G"/>	SF <input style="width: 50px;" type="text"/> DESIGN <input style="width: 50px;" type="text"/> CODE <input style="width: 50px;" type="text"/>
NEMA NOM EFFICIENCY <input style="width: 50px;" type="text" value="95.8"/> NOM PF <input style="width: 50px;" type="text" value="84.7"/> KiloWatt <input style="width: 50px;" type="text" value="373.00"/>	NEMA NOM EFFICIENCY <input style="width: 50px;" type="text"/> NOM PF <input style="width: 50px;" type="text"/>
GUARANTEED EFFICIENCY <input style="width: 50px;" type="text" value="95.0"/> MAX KVAR <input style="width: 50px;" type="text" value="116"/> HZ <input style="width: 50px;" type="text" value="60"/>	GUARANTEED EFFICIENCY <input style="width: 50px;" type="text"/> MAX KVAR <input style="width: 50px;" type="text"/> HZ <input style="width: 50px;" type="text"/>

HAZARDOUS LOCATION DATA (IF APPLICABLE):

DIVISION <input style="width: 100%;" type="text" value="2"/>	CLASS I <input style="width: 100%;" type="text" value="I"/>	GROUP I <input style="width: 100%;" type="text" value="ABCD"/>
TEMP CODE <input style="width: 100%;" type="text" value="T3"/>	CLASS II <input style="width: 100%;" type="text"/>	GROUP II <input style="width: 100%;" type="text"/>

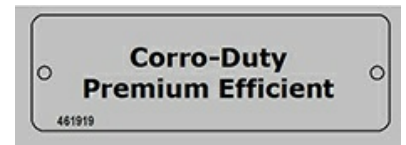

VFD DATA (IF APPLICABLE):

VOLTS <input style="width: 100%;" type="text"/>	AMPS <input style="width: 100%;" type="text"/>
TORQUE 1 <input style="width: 100%;" type="text"/>	TORQUE 2 <input style="width: 100%;" type="text"/>
VFD LOAD TYPE 1 <input style="width: 100%;" type="text"/>	VFD LOAD TYPE 2 <input style="width: 100%;" type="text"/>
VFD HERTZ RANGE 1 <input style="width: 100%;" type="text"/>	VFD HERTZ RANGE 2 <input style="width: 100%;" type="text"/>
VFD SPEED RANGE 1 <input style="width: 100%;" type="text"/>	VFD SPEED RANGE 2 <input style="width: 100%;" type="text"/>
SERVICE FACTOR <input style="width: 100%;" type="text"/>	FL SLIP <input style="width: 100%;" type="text"/>
NO. POLES <input style="width: 100%;" type="text" value="4"/>	MAGNETIZING AMPS <input style="width: 100%;" type="text" value="19.7"/>
VECTOR MAX RPM <input style="width: 100%;" type="text"/>	Encoder PPR <input style="width: 100%;" type="text"/>
Radians / Seconds <input style="width: 100%;" type="text"/>	Encoder Volts <input style="width: 100%;" type="text"/>

TEAO DATA (IF APPLICABLE):

HP (AIR OVER) <input style="width: 100%;" type="text"/>	HP (AIR OVER M/S) <input style="width: 100%;" type="text"/>	RPM (AIR OVER) <input style="width: 100%;" type="text"/>	RPM (AIR OVER M/S) <input style="width: 100%;" type="text"/>
FPM AIR VELOCITY <input style="width: 100%;" type="text"/>	FPM AIR VELOCITY M/S <input style="width: 100%;" type="text"/>	FPM AIR VELOCITY SEC <input style="width: 100%;" type="text"/>	

ADDITIONAL NAMEPLATE DATA:

Decal / Plate	WD=438252	Customer PN	
Notes		Non Rev Ratchet	
Max Temp Rise	80C RISE/RES@1.00SF	OPP/Upper Oil Cap	GREASE
Thermal (WDG)		SHAFT/Lower Oil Cap	GREASE
Altitude		Usable At	
Regulatory Notes		Regulatory Compliance	
COS		Marine Duty	
Balance	0.06 IN/SEC	Arctic Duty	
3/4 Load Eff.	96.0	Inrush Limit	
Motor Weight (LBS)	6000	Direction of Rotation	
Sound Level	85 DBA @ 1M	Special Note 1	
Vertical Thrust (LBS)		Special Note 2	
Thrust Percentage		Special Note 3	
Bearing Life		Special Note 4	
Starting Method		Special Note 5	
Number of Starts		Special Note 6	
200/208V 60Hz Max Amps		SH Max. Temp.	MAX SH TEMP=160 C
190V 50 hz Max Amps		SH Voltage	SH VOLTS=115V
380V 50 Hz Max Amps		SH Watts	SH WATTS=384W
NEMA Inertia		Load Inertia	
Sumpheater Voltage		Sumpheater Wattage	
Special Accessory Note 1	BEARING SET POINTS	Special Accessory Note 16	
Special Accessory Note 2	ALARM= 120C	Special Accessory Note 17	AFFIX N/P 915592
Special Accessory Note 3	SHUTDOWN= 130C	Special Accessory Note 18	
Special Accessory Note 4		Special Accessory Note 19	
Special Accessory Note 5		Special Accessory Note 20	
Special Accessory Note 6		Special Accessory Note 21	
Special Accessory Note 7		Special Accessory Note 22	
Special Accessory Note 8		Special Accessory Note 23	
Special Accessory Note 9		Special Accessory Note 24	WINDING SET POINTS
Special Accessory Note 10		Special Accessory Note 25	ALARM= 160C
Special Accessory Note 11		Special Accessory Note 26	SHUTDOWN= 165C
Special Accessory Note 12		Special Accessory Note 27	AFFIX N/P 839471
Special Accessory Note 13		Special Accessory Note 28	
Special Accessory Note 14		Special Accessory Note 29	
Special Accessory Note 15		Special Accessory Note 30	
Heater in C/B Voltage		Heater in C/B Watts	
Zone 2 Group		Division 2 Service Factor	1.00
Note 1		Note 2	
Note 3		Note 4	
Note 5		Note 6	
Note 7		Note 8	
Note 9		Note 10	
Note 11		Note 12	
Note 13		Note 14	
Note 15		Note 16	
Note 17		Note 18	
Note 19		Note 20	
Note 21		Note 22	

NIDEC MOTOR CORPORATION
ST. LOUIS, MO

TYPICAL NAMEPLATE DATA
ACTUAL MOTOR NAMEPLATE LAYOUT MAY VARY
SOME FIELDS MAY BE OMITTED



MOTOR PERFORMANCE

MODEL NO.	CATALOG NO.	PHASE	TYPE	FRAME
HH92	C500P2W	3	JCE	5012S
ORDER NO.		27329		LINE NO.
MPI:			273666	273667
HP:			500	500
POLES:			4	4
VOLTS:			4000	2300
HZ:			60	60
SERVICE FACTOR:			1.15	1.15
EFFICIENCY (%):				
S.F.			95.7	95.7
FULL			95.8	95.8
3/4			96	96
1/2			95.3	95.3
1/4			92.3	92.3
POWER FACTOR (%):				
S.F.			85	85
FULL			84.7	84.7
3/4			82.6	82.7
1/2			76.2	76.3
1/4			57.1	57.4
NO LOAD			4.9	5
LOCKED ROTOR			19	19
AMPS:				
S.F.			76	132
FULL			66	115
3/4			51	88
1/2			37	64
1/4			25.5	44
NO LOAD			19.7	34
LOCKED ROTOR			411.4	709.5
NEMA CODE LETTER			G	G
NEMA DESIGN LETTER			B	B
FULL LOAD RPM			1785	1785
NEMA NOMINAL / EFFICIENCY (%)			95.8	95.8
GUARANTEED EFFICIENCY (%)			95	95
MAX KVAR			116	115.1
AMBIENT (°C)			40	40
ALTITUDE (FASL)			3300	3300
SAFE STALL TIME-HOT (SEC)			24	24
SOUND PRESSURE (DBA @ 1M)			85	85
TORQUES:				
BREAKDOWN{% F.L.}			269	267
LOCKED ROTOR{% F.L.}			97	96
FULL LOAD{LB-FT}			1469.3	1469.4

NEMA Nominal and Guaranteed Efficiencies are up to 3,300 feet above sea level and 25 ° C ambient.

The Above Data Is Typical, Sinewave Power Unless Noted Otherwise

NIDEC MOTOR CORPORATION
ST. LOUIS, MO





Motor Wiring Diagram 6 Lead, 1.73 to 1 Ratio Dual Voltage or WYE Start - Delta Run on Low Volts

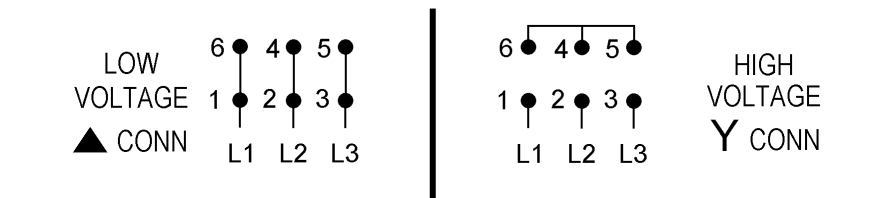

1.73 TO 1 VOLTAGE RATIO: CONNECT FOR HIGH VOLTS ON Y AND LOW VOLTS ON ▲. MOTOR ALSO SUITABLE FOR Y START, ▲ RUN AT THE LOWER VOLTAGE.

EACH LEAD MAY CONSIST OF ONE OR MORE CABLES HAVING THE SAME LEAD NUMBER.

In a 1.73 to 1 ratio, dual voltage application, this motor is operated on the WYE connection for high volts or on the DELTA connection for low volts.

It may also be used as a WYE Start - DELTA Run motor on low volts only.

Per NEMA MG1 1998-1.76, "A Wye Start, Delta Run motor is one arranged for starting by connecting to the supply with the primary winding initially connected in wye, then reconnected in delta for running condition." This is accomplished by a special Wye-Delta starter configuration using six leads from the motor and is intended to limit the inrush current required to start the motor. Damage will occur if the motor is operated with load for more than 30 seconds on the Wye without transition to Delta.

To reverse direction of rotation, interchange leads L1 & L2.

Each lead may have one or more cables comprising that lead. In such case, each cable will be marked with the appropriate lead number.

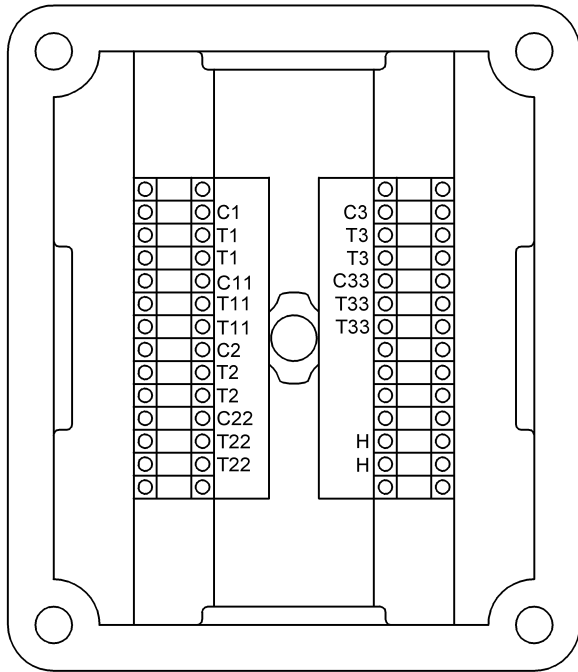

1. THERE ARE QTY-6 RESISTANCE TYPE TEMPERATURE DETECTORS (RTD) INSTALLED IN THE STATOR WINDING. REFER TO NAMEPLATE ATTACHED TO THE MOTOR ADJACENT TO ACCESSORY OUTLET BOX FOR RATING THE RTD'S.

2. DETECTORS ARE INSTALLED IN PHASES AS SHOWN.

PHASE	A	B	C
RTD NO.	1,11	2,22	3,33

3. THERE ARE ANTI-CONDENSATION SPACE HEATERS INSTALLED IN THE MOTOR. REFER TO NAMEPLATE ATTACHED TO THE MOTOR ADJACENT TO ACCESSORY OUTLET BOX FOR HEATER VOLTS AND WATTS.

4. HEATERS SHOULD BE WIRED SUCH THAT THEY ARE ENERGIZED WHEN MOTOR IS NOT RUNNING.

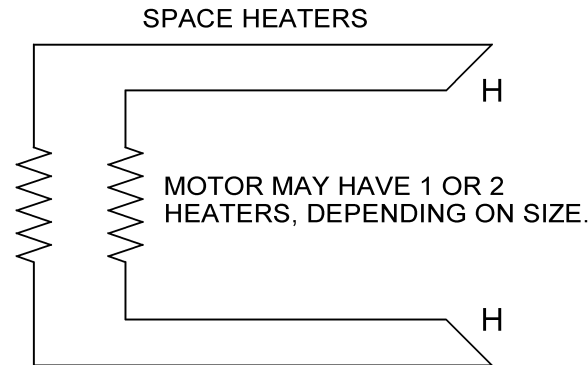
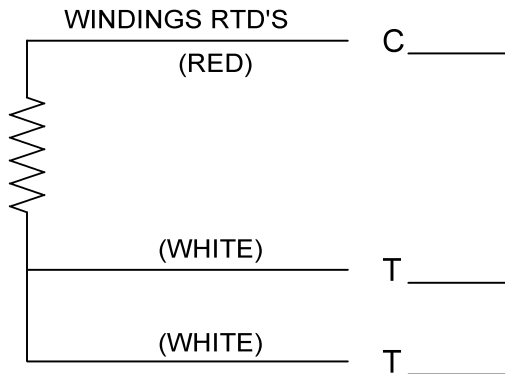

ACCESSORY LISTING
QTY-6 3 LEAD RTD'S SPACE HEATERS

REVISION DESCRIPTION FOR: MISC	SCALE	UNITS	TITLE	NIDEC MOTOR CORPORATION
STL0812-00 UPDATED TO NIDEC FORMAT.	NONE	IN	CUSTOMER CONNECTION, DIAGRAM	
	TOLERANCES ON DIMENSIONS (UNLESS OTHERWISE SPECIFIED)			
	INCHES	mm		
MATERIAL:			ISSUED BY	REVISION DATE
----			R. KING	15-AUG-12
			APPROVED BY	
			T. FLINCHUM	
			CODE	DWG NO.
				0833990
	ANGLES X°= ±1°		REV	SHEET NUMBER
			C	1 OF 1
				DWG SIZE
				A

RENEWAL PARTS

FRAMES 5000 AND 5800

TYPES: J, JP, JC, JCE, JCEI, JCI, JDE, JDEI, JE, JEI, JI

ITEM	DESCRIPTION	QTY
1	STATOR ASSM., WOUND	1
1A	PLUG, VENT	2
1B	PLUG, HEX C'SUNK	A/R
1C	NIPPLE, PIPE (SEP O/B)	A/R
1D	PLATE, ADAPTOR	A/R
1E	PLUG, HEX C'SUNK	6
2	ROTOR ASSEMBLY	1
3	BRACKET (ODE)	1
3A	SCREW, HEX HD CAP	8
3B	NIPPLE, PIPE	2
3C	COUPLING, PIPE	2
3D	PLUG, HEX C'SUNK	2
3E	BRACKET, SUPPORT	2
3F	SCREW, HEX HD CAP	2
3G	NIPPLE, PIPE	2
3H	COUPLING, PIPE	2
3J	FITTING, GREASE	2
3K	FITTING, PIPE EXTENDER	A/R
3L	BEARING TEMP PROBE	A/R
3M	HOLDER, RTD	A/R
3N	BASE, OUTLET BOX	A/R
3P	GASKET	1
3R	COVER, OUTLET BOX	A/R
3S	SCREW	A/R
3T	PLUG, HEX C'SUNK	A/R
4	SNAP RING	1
5	BEARING, BALL (ODE)	1
6	BEARING CAP (ODE)	1
6A	SCREW, HEX HD CAP	8
7	BRACKET (DE)	1
8	SPRING, WASHER, WAVE (DE)	1
9	BEARING (DE)	1
10	RING, SPACER (DE)	A/R
11	BEARING CAP (DE)	1
12	BUSHING/SEAL (ODE)	1
13	DEFLECTOR, WATER (ODE)	1
14	BUSHING/SEAL (DE)	1
15	DEFLECTOR, WATER (DE)	1
16	KEY, SQUARE	1
17	FAN	1
17A	SNAP RING	1
18	COVER, FAN	1
18A	SCREW, HEX HD CAP	4
18B	PLUG, SHEET METAL	A/R

ITEM	DESCRIPTION	QTY
18C	PLUG, SHEET METAL	2
18D	SCREW, SET	1
19	PLATE, COVER (BLANK)	2
19A	SCREW, SELF TAPPING	8
20	SCREEN, AIR	1
20A	SCREW, HEX HD CAP	4
21	SCOOP	2
21A	SCREW, HEX HD CAP	4
22	GASKET (LEAD TUBE)	1
23	TUBE, LEAD	1
23A	SCREW, HEX HD CAP	6
23B	GROUNDING CABLE (MAIN O/B)	1
23C	SCREW, HEX HD CAP	1
24	GASKET (OUTLET BOX)	1
25	OUTLET BOX BASE (MAIN)	1
25A	STUD	6
25B	WASHER, RUBBER	4
25C	SPACER (O/B BRACE)	2
25D	WASHER, PLAIN	6
25E	WASHER, LOCK, SPLIT	6
25F	NUT, HEX	6
25G	GASKET	2
25H	COVER	2
25J	SCREW, HEX HD CAP	8
25K	WASHER, LOCK, SPLIT	8
26	GASKET (MAIN O/B COVER)	1
27	COVER (MAIN O/B)	1
27A	SCREW, HEX HD CAP	8
27B	WASHER, LOCK, SPLIT	8
28	GASKET (LARGE SEP O/B, COMBINATION)	1
29	OUTLET BOX BASE (LARGE SEP)	1
29A	SCREW, HEX HD CAP	4
29B	WASHER, LOCK, SPLIT	4
30	COVER, O/B (LARGE SEP)	1
30A	SCREW, HEX HD CAP	4
30B	WASHER, LOCK, SPLIT	4
31	GASKET (SMALL SEP O/B, COMBINATION)	1
32	OUTLET BOX BASE (SMALL SEP)	1
32A	SCREW, HEX HD CAP	4
32B	WASHER, LOCK, SPLIT	4
33	COVER, O/B (SMALL SEP)	1
33A	A SCREW, HEX HD CAP	2
33B	WASHER, LOCK, SPLIT	2

General Information for Integral Horsepower (IHP) Motors on Variable Frequency Drives (VFDs)

Variable Frequency Drives (VFD)

A VFD is a type of controller used to vary the speed of an electric motor. The VFD takes a fixed AC voltage and frequency and allows it to be adjusted in order to get different speeds from the motor. Motor speed can be varied by changing the frequency of the input power waveform. The equation below shows how the frequency affects the speed of a three phase induction motor.

$$\text{Speed} = \frac{120 * \text{Fundamental Input Frequency}}{\text{Number of Motor Poles}}$$

How does a VFD work?

A VFD takes the fixed frequency and voltage sine wave from the power grid or power station and puts it through a few steps in order to allow the VFD user to vary the frequency and in turn control the motor speed. First it rectifies the AC power into DC Power. Because of this step, a term commonly used instead of VFD is inverter. This only describes one step of what the VFD does to the power waveform. Once rectified into a DC voltage the drive sends the power through a set of transistors or switches. These switches can take the DC waveform and by opening and closing at certain speeds and durations can create an output waveform that mimics the sine wave that is required to drive a three phase electric motor. The output wave form is known as a Pulse Width Modulation (PWM) waveform because the waveform is created by multiple pulses of the switches at short intervals.

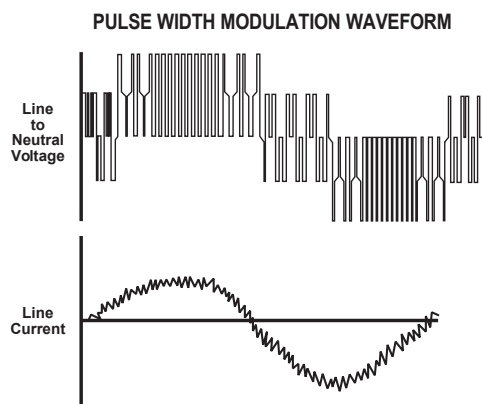

Figure 1 PWM Waveform

What variables should be considered when deciding whether to power a motor with a VFD?

VFD compatibility with motors is complex. As a result, many variables must be considered when determining the suitability of a particular motor for use with a VFD. These variables include:

- Torque requirements (Constant or Variable)
- Speed Range
- Line / System Voltage
- Cable length between the VFD and the motor
- Drive switching (carrier) frequency
- Motor construction

- VFD dv/dt - winding end turn differential in voltage versus differential in time
- High temperatures or high humidity
- Grounding system

Wider speed ranges, higher voltages, higher switching frequencies, insufficient grounding and increased cable lengths all add to the severity of the application and, therefore, the potential for premature motor failure.

How does a VFD affect the motor?

There are many things to consider when a motor is powered using a VFD or PWM power. When a motor is powered by a PWM waveform the motor windings very often see a large differential voltage, either from phase to phase or turn to turn. When the voltage differential becomes large enough it creates a reaction at the molecular level that converts available oxygen into O₃. This phenomenon is called partial discharge or corona. This reaction creates energy in the form of light and heat. This energy has a corrosive effect on the varnish used to protect the motor windings. PWM waveforms can also magnify shaft voltages which lead to arcing across the bearing and causing premature bearing failure. Corrective action must be taken to mitigate these issues that arise when using an electric motor with a VFD.

How do I protect the motor?

Nidec Motor Corporation (NMC) has developed specific motor designs to decrease the harmful affects that a VFD can have on a motor. NMC's INVERTER GRADE[®] insulation system is the first line of defense against corona and phase to phase faults that can be common when a motor is powered using a PWM waveform. The INVERTER GRADE[®] insulation system is standard on all of NMC's Inverter Duty products. Along with the INVERTER GRADE[®] insulation, thermostats are installed as a minimum protection against over heating the motor. Special consideration must also be given to bearings in motors powered by VFD's. In order to create a low resistance path to ground for built up shaft voltages a shaft grounding device can be used. On larger horsepower motors an insulated bearing system should be used in conjunction with the shaft grounding device when installed, to force the stray shaft voltages to ground. The bearing failures are more prominent on motors with thrust handling bearings. NMC has created an Inverter Duty vertical motor line that not only uses the INVERTER GRADE[®] insulation system, but that also comes standard with a shaft grounding device. On motors that are 100 HP and greater the thrust bearing is also insulated for additional protection.

What does "Inverter Duty" mean?

An Inverter Duty motor should describe a motor that helps mitigate potential failure modes of a motor that is powered by a VFD. Inverter duty motor windings should be able to withstand the voltage spikes per NEMA MG1 Part 31.4.4.2 and protect against overheating when the motor is run at slow speeds. On thrust handling bearings it is apparent that the bearings require additional protection. Inverter Duty vertical motors should have a shaft grounding device to protect the motor bearings from fluting due to voltage discharge through the bearing. On larger motors (100HP and larger) the shaft should also be electrically isolated from the frame in order to aid the shaft grounding ring in discharging the shaft voltages to ground.

*This information applies only to Integral Horsepower (IHP) motors as defined on the Agency Approval page, under UL[®] & CSA[®] listings where indicated.

Thermal Overloads and Single Phase Motors

Motors with thermal overloads installed may not operate properly on a VFD. The current carrying thermal overload is designed for sine wave power. Operation on a VFD may cause nuisance tripping or potentially not protect the motor as would be expected on line power. Thermostats or thermistors installed in the motor and connected properly to the VFD may provide suitable thermal overload protection when operating on a VFD. (consult codes for installation requirements)

Single phase motors and other fractional horsepower ratings are not designed to be operated on a VFD. Within Nidec Motor Corporation standard products, all motors NEMA[®] 48 frame (5.5" diameter) and smaller are not suitable for VFD applications. Three phase 56 and 143/145 frame applications should be noted on the catalog price page; or if in doubt ask a Nidec Motor Corporation technical representative for recommendations on compatibility with a VFD.

Slow Speed Motors

Motors with a base design of slower than six poles require special consideration regarding VFD sizing and minimizing harmonic distortion created at the motor terminals due to cable installation characteristics. Additional external PWM waveform filters and shielded motor cables designed for PWM power may be required to provide acceptable motor life. Harmonic distortion on the output waveform should be kept to a minimum level (less than 10%) mismatch impedance.

690V Applications

Motors that are rated for 690VAC and that will be powered by 690VAC PWM VFDs require the use of an external filter to limit peak voltage spikes and the use of an INVERTER GRADE[®] motor. Where available, an alternative to using an output filter is to upgrade to a 2300V insulation system.

Low Voltage TITAN[®] Motors

When using 449 frame and larger motors on PWM type VFDs consider the use of an external filter and shielded motor cables designed for PWM power to minimize harmonic distortion and peak voltages at the motor terminals. Harmonic distortion on the output waveform should be kept to a minimum level (less than 10%).

Bearing Currents Related to PWM Waveforms

Protection of the motor bearings from shaft currents caused by common mode voltages is becoming a standard feature on Inverter Duty motor products. Some installations may be prone to a voltage discharge condition through the motor bearings called Electrical Discharge Machining (EDM) or fluting. Vertical HOLLOWSHAFT and HOSTILE DUTY World Motor come with grounding devices installed as standard. EDM damage is related to characteristics of the PWM waveform, and the VFD programming, and installations factors.

Bearing Protection on Inverter Duty Vertical Motors

All U.S. MOTORS[®] brand "Inverter Duty" vertical products have a shaft grounding system that allows damaging shaft currents a low resistance path to ground. **Bearings on vertical motors fed by VFD power without this bearing protection are not covered under any warranty.** All other bearing failure is covered per NMC's standard warranty. An electric motor repair shop approved to service U.S. MOTORS[®] brand motors must verify that the cause of the bearing failure was not due to EDM damage.

Guideline For Insulated Anti-Friction Bearings

Bearing insulation is required to prevent circulating shaft currents which can damage bearings. Circulating shaft current can be caused by use of improper power and/or ground cables, improper grounding systems and higher switching frequencies. Finding and correcting the external condition(s) is the responsibility of the system designer or specifying engineer. To prevent circulating shaft current in motors with anti-friction bearings, Nidec Motor Corporation's standard practice is to insulate the non-drive end bearing.

Adjustable Speed Drives produce a common mode voltage condition. To interrupt common mode voltage on induction motors of all sizes, NEMA MG1-2018 Part 31 recommends insulating both bearings. In cases where both anti-friction bearings are insulated, the system designer or specifying engineer should determine whether to apply one or more of the following options to prevent or reduce shaft currents: sinewave filters, line reactors or mechanical devices, such as shaft grounding or an insulated half coupling. Motors with shaft grounding devices are not suitable for installation in hazardous locations unless housed in an enclosure suitable for the specified Division (or Zone), Class and Group(s).

Multiple Motors on a Single VFD

Special considerations are required when multiple motors are powered from a single VFD unit. Most VFD manufacturers can provide guidelines for proper motor thermal considerations and starting/stopping of motors. Cable runs from the VFD and each motor can create conditions that will cause extra stress on the motor winding. Filters may be required at the motor to provide maximum motor life.

Grounding and Cable Installation Guidelines

Proper output winding and grounding practices can be instrumental in minimizing motor related failures caused by PWM waveform characteristics and installation factors. VFD manufacturers typically provide detailed guidelines on the proper grounding of the motor to the VFD and output cable routing. Cabling manufacturers provide recommended cable types for PWM installations and critical information concerning output wiring impedance and capacitance to ground.

Integrated Motor and Inverter

By integrating the motor and inverter at NMC's manufacturing facility, many of the motor compatibility problems are minimized or eliminated. During the manufacturing process, the motor is matched to the inverter characteristics which ensures the winding temperature and torque levels meet the design specification. Since the inverter output wiring to the motor is nearly eliminated, bearing currents are rarely experienced. When the unit is properly grounded, reducing the output cable lengths in conjunction with an inverter grade insulation system and low factory setting of the switching frequency of the inverter drive, results in low risk of voltage peaks produced by the PWM waveform.

Vertical Motors on VFDs

Vertical motors operated on VFD power present unique conditions that may require consideration by the user or installation engineer:

- Locked rotor and drive tripping caused by non-reversing-ratchet operation at low motor speeds. It is not recommended to operate motors at less than 1/4 of synchronous speed. If slow speeds are required contact NMC engineering.
- Unexpected / unacceptable system vibration and or noise levels caused by the torque pulsation characteristics of the PWM waveform, a system critical frequency falling inside the variable speed range of the process or the added harmonic content of the PWM waveform exciting a system component
- Application related problems related to the controlled acceleration/deceleration and torque of the motor on VFD power and the building of system pressure/ load.
- The impact the reduction of pump speed has on the down thrust reflected to the pump motor and any minimum thrust requirements of the motor bearings
- Water hammer during shutdown damaging the non-reversing ratchet

Humidity and Non-operational Conditions

The possible build-up of condensation inside the motor due to storage in an uncontrolled environment or non-operational periods in an installation, can lead to an increased rate of premature winding or bearing failures when combined with the stresses associated with PWM waveform characteristics. Moisture and condensation in and on the motor winding over time can provide tracking paths to ground, lower the resistance of the motor winding to ground, and lower the Corona Inception Voltage (CIV) level of the winding.

Proper storage and maintenance guidelines are important to minimize the potential of premature failures. Space heaters or trickle voltage heating methods are the common methods for drying out a winding that has low resistance readings. **Damage caused by these factors are not covered by the limited warranty provided for the motor unless appropriate heating methods are properly utilized during non-operational periods and prior to motor start-up.**

NEMA[®] Application Guide for AC Adjustable Speed Drive Systems: <http://www.nema.org/stds/acadjustable.cfm#download>

* This information applies only to Integral Horsepower (IHP) motors as defined on the Agency Approval page, under UL[®] & CSA[®] listings where indicated.

Warranty Guidelines for Integral Horsepower (IHP)* Motors on Variable Frequency Drives

Warranty Guidelines

The information in the following section refers to the motor and drive application guidelines and limitations for warranty.

Hazardous Location Motors

Use of a variable frequency drive with the motors in this catalog, intended for use in hazardous locations, is only approved for Division 1, Class I, Group D hazardous location motors with a T2B temperature code, with a limitation of 2:1 constant torque or 10:1 variable torque output. **No other stock hazardous location motors are inherently suitable for operation with a variable frequency drive.** If other requirements are needed, including non-listed Division 2, please contact your Nidec Motor Corporation territory manager to conduct an engineering inquiry.

575 Volt Motors

575 volt motors can be applied on Inverters when output filters are used. Contact the drive manufacturer for filter selection and installation requirements.

Applying INVERTER GRADE® Insulated Motors on Variable Frequency Drives (2, 4, 6 pole)

The products within this catalog labeled “Inverter Duty” or “Vector Duty” are considered INVERTER GRADE® insulated motors. INVERTER GRADE® motors exceed the NEMA® MG-1 Part 31 standard. Nidec Motor Corporation provides a three-year limited warranty on all NEMA® frame INVERTER GRADE® insulated motors and allows long cable runs between the motor and the VFD (limited to 400 feet without output filters). Cable distance can be further limited by hot and humid environments and VFD manufacturers cable limits. These motors may be appropriate for certain severe inverter applications or when the factors relating to the end use application are undefined (such as spares).

Nidec Motor Corporation’s U.S. Motors® brand is available in the following INVERTER GRADE® insulated motors:

- Inverter Duty NEMA® frame motors good for 20:1 Variable Torque & 5:1 Constant Torque, including Vertical Type RUSI (10:1 V.T.)
- Inverter Duty motors rated for 20:1 Constant Torque
- ACCU-Torq® and Vector Duty Motors with full torque to 0 Speed or 5000:1
- 841 Plus® NEMA® Frame Motors

Applying Premium Efficient motors (that do not have INVERTER GRADE® insulation) on Variable Frequency Drives (2, 4, 6 pole)

Premium efficient motors without INVERTER GRADE insulation meet minimum NEMA® MG-1, Section IV, Part 31.4.4.2. These motors can be used with Variable Frequency Drives (with a reduced warranty period) under the following parameters:

- On NEMA® frame 447 and smaller motors, 20:1 speed rating on variable torque loads & 4:1 speed range on constant torque loads.
- On TITAN® 449 and larger frame motors, 10:1 speed rating on variable torque loads.

- On TITAN® frame motors, inquiry required for suitability on constant torque loads.

Cable distances are for reference only and can be further limited by hot and humid environments (refer to Table 1). Refer to specific VFD

Table 1 - Cable Distances			
Maximum Cable Distance VFD to Motor			
Switching Frequency	460 Volt	230 Volt	380 Volt
3 KHz	127 ft	400 ft	218 ft
6 KHz	90 ft	307 ft	154 ft
9 KHz	73 ft	251 ft	126 ft
12 KHz	64 ft	217 ft	109 ft
15 KHz	57 ft	194 ft	98 ft
20 KHz	49 ft	168 ft	85 ft

manufacturers cable limits. Refer to the Motor/ Inverter Compatibility page for special consideration of vertical motor bearings.

Warranty Period Clarifications and Exceptions

Standard Energy Efficient Exclusion

Applying Standard & Energy Efficient Motors on Variable Frequency Drives is not recommended. VFD related failures on standard and energy efficient motors will not be covered under warranty.

Vertical Motor Windings

Premium efficient vertical motors without INVERTER GRADE® insulation that are installed using the criteria described in this document and applied in the correct applications shall have a warranty while powered by a VFD for 12 months from date of installation or 18 months from date of manufacturing whichever comes first. See limited warranty page for horizontal motor warranty periods.

Bearing Exclusion for Thrust Handling Bearings

Bearings used in premium efficient vertical motors, and all thrust handling bearings, that are powered by VFDs without shaft grounding devices or insulated bearings (when required) will not be covered under any warranty for damages caused from being powered by a VFD. All other bearing failure is covered per NMC’s standard warranty. An electric motor repair shop approved to service U.S. MOTORS® brand motors must verify that the cause of the bearing failure was not due to Electrical Discharge Machining.

Medium Voltage and Slow Speed Considerations

Motors that are rated above 700 VAC or that are eight pole and slower require special consideration and installation and are not covered under the warranty guidelines in this document. Motors that are rated above 700VAC have special cable length and voltage differential issues that are specific to the VFD type and manufacture. The motor construction and cost may vary dramatically depending on the VFD topology and construction. Contact your NMC representative with VFD manufacturer name and model type for application and motor construction considerations. Motors that are designed eight pole and slower also require special installation and filters per the drive manufacturer.

* This information applies only to Integral Horsepower (IHP) motors as defined on the Agency Approval page, under UL® & CSA® listings where indicated.